



# RockStar® – Heavy-Duty Connectors

Product Catalogue

# RockStar® – Heavy-Duty Connectors

<b>RockStar® inserts</b>		<b>ConCept modular system</b>	10
HE series	4		
CabinetMate-HE series	5	<b>RockStar® housing, IP65</b>	12
HA series	6		
HD series	7	<b>RockStar® housing, IP69K</b>	16
CabinetMate-HD series	7		
HDD series	8	<b>Cable glands</b>	17
HVE series	8		
MixMate series	9	<b>Kits</b>	18
HEE series	9		
HQ series	9	<b>Accessories</b>	20
HSB series	9		

## Allocations

Housing	Inserts				
Size 1	HA 3, HA 4	HD 7, HD 8	HQ5		
Size 2	HA 10	HD 15			
Size 3	HE 6, HEE 10, modular: ConCept for 2 modules	HD 16	HDD 24		S 4
Size 4	HE 10, HEE 18, modular: ConCept for 3 modules	HD 24	HDD42	HVE 3 + 2	
Size 5	HA 16	HD 25			
Size 6	HE 16, HEE 32, modular: ConCept for 5 modules	HD 40	HDD 72	HVE 6 + 2	HSB 6
Size 7	HA 32	HD 50			S 4/0, S 6/12
Size 8	HE 24, HEE 46, modular: ConCept for 7 modules	HD 64	HDD 108	HVE 10 + 2	
Size 9	HA 48				S 6/6
Size 10	HE 32, modular: ConCept for 10 modules	HD 80	HDD 144		HSB 12
Size 12	HE 48, modular: ConCept for 14 modules	HD 128	HDD 216		

## Applications

RockStar® heavy-duty connectors (HDC) are required in a wide range of electrical and electronic machines and systems: general mechanical engineering, materials-handling technology, plant engineering, packaging machines, lighting and stage technology, fairground rides, process engineering, transport and traffic engineering.

### IP65/NEMA 4X housing

- IP65 class of protection to EN 60529 (1991) + part A1 (2000)
- NEMA 4X class of protection
- Scratch-resistant, corrosion-resistant, long-lasting
- Locking levers made from non-rusting stainless steel

### IP69K housing – the highest level of protection

- IP69K class of protection to DIN 40050 part 9 (1993): no detrimental effects from high-pressure water jet directed against housing from any direction
- Class of protection IP68/5 bar to EN 60529 (1991) + part A1 (2000)
- Scratch-resistant, corrosion-resistant, long-lasting
- Screw locking

## Regulations

DIN EN 60664-1 or IEC 60664-1:

Insulation coordination for equipment within low-voltage systems – Part 1: Principles, requirements and tests

DIN EN 61984 or IEC 61984:

Connectors – Safety requirements and tests

DIN EN 175301-801:

Detail specification – High density rectangular connectors, round removable crimp contacts (supersedes DIN 43652)

Approvals:

UL, CSA for contact inserts; UL, GL for plug housings





We reserve the right to make changes which reflect quality improvements, further developments or manufacturing requirements.

Please note that the given technical properties can only be guaranteed when all components are supplied by Weidmüller.

# Inserts

## HE series

Series	HE - size 3	HE - size 4	HE - size 6	HE - size 8
No. of poles	6 + ⊕	10 + ⊕	16 + ⊕	24 + ⊕
Connection	tension clamp	tension clamp	tension clamp	tension clamp

Rated current	24 A	16 A	16 A	16 A
Rated voltage	500 V	500 V	500 V	500 V
Nominal voltage to UL/CSA	600 V	600 V	600 V	600 V
Clamping range	0.5 – 2.5 mm <sup>2</sup>	0.5 – 2.5 mm <sup>2</sup>	0.5 – 2.5 mm <sup>2</sup>	0.5 – 2.5 mm <sup>2</sup>
Order No., female	1745760000	1745770000	1745780000	1745790000
Order No., male	1745820000	1745830000	1745840000	1745850000





Series	HE - size 3	HE - size 4	HE - size 6	HE - size 8
No. of poles	6 + ⊕	10 + ⊕	16 + ⊕	24 + ⊕
Connection	screw	screw	screw	screw





Rated current	24 A	16 A	16 A	16 A
Rated voltage	500 V	500 V	500 V	500 V
Nominal voltage to UL/CSA	600 V	600 V	600 V	600 V
Clamping range	0.5 – 2.5 mm <sup>2</sup>	0.5 – 2.5 mm <sup>2</sup>	0.5 – 2.5 mm <sup>2</sup>	0.5 – 2.5 mm <sup>2</sup>
Order No., female	1200200000	1204100000	1207700000	1211300000
Order No., male	1200000000	1203900000	1207500000	1211100000

Series	HE - size 3	HE - size 4	HE - size 6	HE - size 8
No. of poles	6 + ⊕	10 + ⊕	16 + ⊕	24 + ⊕
Connection	Push In	Push In	Push In	Push In

Rated current	24 A	16 A	16 A	16 A
Rated voltage	500 V	500 V	500 V	500 V
Nominal voltage to UL/CSA	600 V	600 V	600 V	600 V
Clamping range	0.5 – 2.5 mm <sup>2</sup>	0.5 – 2.5 mm <sup>2</sup>	0.5 – 2.5 mm <sup>2</sup>	0.5 – 2.5 mm <sup>2</sup>
Order No., female	1873520000	1873540000	1873560000	1873580000
Order No., male	1873530000	1873550000	1873570000	1873590000

Series	HE - size 3	HE - size 4	HE - size 6	HE - size 8
No. of poles	6 + ⊕	10 + ⊕	16 + ⊕	24 + ⊕
Connection	crimp	crimp	crimp	crimp









Rated current	24 A	16 A	16 A	16 A
Rated voltage	500 V	500 V	500 V	500 V
Nominal voltage to UL/CSA	600 V	600 V	600 V	600 V
Clamping range	0.5 – 4 mm <sup>2</sup>	0.5 – 4 mm <sup>2</sup>	0.5 – 4 mm <sup>2</sup>	0.5 – 4 mm <sup>2</sup>
Order No., female	1201000000	1204400000	1208000000	1211600000
Order No., male	1200400000	1204300000	1207900000	1211500000





**HE series**

Series	HE - size 10	HE - size 12	HE - size 10	HE - size 12
No. of poles	32 + ⊕	48 + ⊕	32 + ⊕	48 + ⊕
Connection	tension clamp	tension clamp	screw	screw
				
Rated current	16 A	16 A	16 A	16 A
Rated voltage	500 V	500 V	500 V	500 V
Nominal voltage to UL/CSA	600 V	600 V	600 V	600 V
Clamping range	0.5 – 2.5 mm <sup>2</sup>	0.5 – 2.5 mm <sup>2</sup>	0.5 – 2.5 mm <sup>2</sup>	0.5 – 2.5 mm <sup>2</sup>
Order No., female	1745780000 (1-16)	1745790000 (1-24)	1207700000 (1-16)	1211300000 (1-24)
Order No., female	1745800000 (17-32)	1745810000 (25-48)	1216100000 (17-32)	1221200000 (25-48)
Order No., male	1745840000 (1-16)	1745850000 (1-24)	1207500000 (1-16)	1211100000 (1-24)
Order No., male	1745860000 (17-32)	1745870000 (25-48)	1215700000 (17-32)	1220800000 (25-48)

Series	HE - size 10	HE - size 12	HE - size 10	HE - size 12
No. of poles	32 + ⊕	48 + ⊕	32 + ⊕	48 + ⊕
Connection	Push In	Push In	crimp	crimp
				
Rated current	16 A	16 A	16 A	16 A
Rated voltage	500 V	500 V	500 V	500 V
Nominal voltage to UL/CSA	600 V	600 V	600 V	600 V
Clamping range	0.5 – 2.5 mm <sup>2</sup>	0.5 – 2.5 mm <sup>2</sup>	0.5 – 4 mm <sup>2</sup>	0.5 – 4 mm <sup>2</sup>
Order No., female	1873560000 (1-16)	1873580000 (1-24)	1208000000 (1-16)	1211600000 (1-24)
Order No., female	1875740000 (17-32)	1875850000 (25-48)	1216700000 (17-32)	1226600000 (25-48)
Order No., male	1873570000 (1-16)	1873590000 (1-24)	1207900000 (1-16)	1211500000 (1-24)
Order No., male	1875800000 (17-32)	1875890000 (25-48)	1216500000 (17-32)	1226400000 (25-48)

**CabinetMate-HE series**

Series	DSTV-HE - size 3	DSTV-HE - size 4	DSTV-HE - size 6	DSTV-HE - size 8
No. of poles	6 + ⊕	10 + ⊕	16 + ⊕	24 + ⊕
Connection	tension clamp	tension clamp	tension clamp	tension clamp
				
Rated current	16 A	16 A	16 A	16 A
Rated voltage	500 V	500 V	500 V	500 V
Nominal voltage to UL/CSA	600 V	600 V	600 V	600 V
Clamping range	0.5 – 2.5 mm <sup>2</sup>	0.5 – 2.5 mm <sup>2</sup>	0.5 – 2.5 mm <sup>2</sup>	0.5 – 2.5 mm <sup>2</sup>
Order No., female ⊕ right	1837430000	1837440000	1837450000	1837460000
Order No., female ⊕ left	1837390000	1837400000	1837410000	1837420000
Order No., male ⊕ right	1837510000	1837520000	1837530000	1837540000
Order No., male ⊕ left	1837470000	1837480000	1837490000	1837500000

Series	DSTV-HE - size 3	DSTV-HE - size 4	DSTV-HE - size 6	DSTV-HE - size 8
No. of poles	6 + ⊕	10 + ⊕	16 + ⊕	24 + ⊕
Connection	screw	screw	screw	screw
				
Rated current	16 A	16 A	16 A	16 A
Rated voltage	500 V	500 V	500 V	500 V
Nominal voltage to UL/CSA	600 V	600 V	600 V	600 V
Clamping range	0.5 – 4 mm <sup>2</sup>	0.5 – 4 mm <sup>2</sup>	0.5 – 4 mm <sup>2</sup>	0.5 – 4 mm <sup>2</sup>
Order No., female ⊕ right	1848600000	1848610000	1848620000	1848630000
Order No., female ⊕ left	1848550000	1848570000	1848580000	1848590000
Order No., male ⊕ right	1848740000	1848750000	1848760000	1848770000
Order No., male ⊕ left	1848660000	1848680000	1848700000	1848730000

# Inserts

## HA series

Series	HA - size 1	HA - size 1
No. of poles	3 + ⊕	4 + ⊕
Connection	screw	screw



Rated current	22 A	22 A
Rated voltage	250 V	250 V
Nominal voltage to UL/CSA	600 V	600 V
Clamping range	0.5 – 2.5 mm <sup>2</sup>	0.5 – 2.5 mm <sup>2</sup>
Order No., female	1498200000	1498400000
Order No., male	1498100000	1498300000

Series	HA - size 2	HA - size 5	HA - size 7	HA - size 9
No. of poles	10 + ⊕	16 + ⊕	32 + ⊕	48 + ⊕
Connection	tension clamp	tension clamp	tension clamp	tension clamp



Rated current	22 A	22 A	16 A	16 A
Rated voltage	250 V	250 V	250 V	250 V
Nominal voltage to UL/CSA	600 V	600 V	600 V	600 V
Clamping range	0.5 – 2.5 mm <sup>2</sup>	0.5 – 2.5 mm <sup>2</sup>	0.5 – 2.5 mm <sup>2</sup>	0.5 – 2.5 mm <sup>2</sup>
Order No., female	1896780000	1896800000	1896800000	1896800000
Order No., female (17-32)			1896810000	1896810000
Order No., female (33-48)				1896820000
Order No., male	1896790000	1896830000	1896830000	1896830000
Order No., male (17-32)			1896840000	1896840000
Order No., male (33-48)				1896850000

Series	HA - size 2	HA - size 5	HA - size 7	HA - size 9
No. of poles	10 + ⊕	16 + ⊕	32 + ⊕	48 + ⊕
Connection	screw	screw	screw	screw



Rated current	22 A	22 A	16 A	16 A
Rated voltage	250 V	250 V	250 V	250 V
Nominal voltage to UL/CSA	600 V	600 V	600 V	600 V
Clamping range	0.5 – 2.5 mm <sup>2</sup>	0.5 – 2.5 mm <sup>2</sup>	0.5 – 2.5 mm <sup>2</sup>	0.5 – 2.5 mm <sup>2</sup>
Order No., female	1650620000	1650780000	1650780000	1650780000
Order No., female (17-32)			1650900000	1650900000
Order No., female (33-48)				1651020000
Order No., male	1650610000	1650770000	1650770000	1650770000
Order No., male (17-32)			1650880000	1650880000
Order No., male (33-48)				1650900000

Series	HA - size 2	HA - size 5	HA - size 7	HA - size 9
No. of poles	10 + ⊕	16 + ⊕	32 + ⊕	48 + ⊕
Connection	crimp	crimp	crimp	crimp



Rated current	22 A	22 A	16 A	16 A
Rated voltage	250 V	250 V	250 V	250 V
Nominal voltage to UL/CSA	600 V	600 V	600 V	600 V
Clamping range	0.5 – 2.5 mm <sup>2</sup>	0.5 – 2.5 mm <sup>2</sup>	0.5 – 2.5 mm <sup>2</sup>	0.5 – 2.5 mm <sup>2</sup>
Order No., female	1873860000	1873880000	1873880000	1873880000
Order No., female (17-32)			1876040000	1876040000
Order No., female (33-48)				1875540000
Order No., male	1873870000	1873890000	1873890000	1873890000
Order No., male (17-32)			1875620000	1875620000
Order No., male (33-48)				1875630000

**HD series**

Series	HD - size 1*	HD - size 1*	HD - size 2	HD - size 3
No. of poles	7 + ⊕	8	15 + ⊕	16 + ⊕
Connection	crimp	crimp	crimp	crimp
				
Rated current	10 A	10 A	10 A	10 A
Rated voltage	250 V	250 V	250 V	250 V
Nominal voltage to UL/CSA	600 V	600 V	600 V	600 V
Clamping range	0.14 – 2.5 mm <sup>2</sup>	0.14 – 2.5 mm <sup>2</sup>	0.14 – 2.5 mm <sup>2</sup>	0.14 – 2.5 mm <sup>2</sup>
Order No., female	1650580000	1650600000	1650660000	1650720000
Order No., male	1650570000	1650590000	1650650000	1650710000

\*Voltage must be limited to 42 V when using metal housings.

Series	HD - size 4	HD - size 5	HD - size 6	HD - size 7
No. of poles	24 + ⊕	25 + ⊕	40 + ⊕	50 + ⊕
Connection	crimp	crimp	crimp	crimp
				
Rated current	10 A	10 A	10 A	10 A
Rated voltage	250 V	250 V	250 V	250 V
Nominal voltage to UL/CSA	600 V	600 V	600 V	600 V
Clamping range	0.14 – 2.5 mm <sup>2</sup>	0.14 – 2.5 mm <sup>2</sup>	0.14 – 2.5 mm <sup>2</sup>	0.14 – 2.5 mm <sup>2</sup>
Order No., female	1650890000	1650820000	1601730000	1650820000*
Order No., male	1650870000	1650810000	1601710000	1650810000*

\*Please use this insert in pairs.

Series	HD - size 8	HD - size 10	HD - size 12
No. of poles	64 + ⊕	80 + ⊕	128 + ⊕
Connection	crimp	crimp	crimp
			
Rated current	10 A	10 A	10 A
Rated voltage	250 V	250 V	250 V
Nominal voltage to UL/CSA	600 V	600 V	600 V
Clamping range	0.14 – 2.5 mm <sup>2</sup>	0.14 – 2.5 mm <sup>2</sup>	0.14 – 2.5 mm <sup>2</sup>
Order No., female	1601740000	1601730000*	1601740000*
Order No., male	1601720000	1601710000*	1601720000*

\*Please use this insert in pairs.

**CabinetMate-HD series**

Series	DSTV-HD - size 3	DSTV-HD - size 4	DSTV-HD - size 6	DSTV-HD - size 8
No. of poles	16 + ⊕	24 + ⊕	40 + ⊕	64 + ⊕
Connection	screw	screw	screw	screw
				
Rated current	10 A	10 A	10 A	10 A
Rated voltage	250 V	250 V	250 V	250 V
Nominal voltage to UL/CSA	600 V	600 V	600 V	600 V
Clamping range	0.5 – 1.5 mm <sup>2</sup>	0.5 – 1.5 mm <sup>2</sup>	0.5 – 1.5 mm <sup>2</sup>	0.5 – 1.5 mm <sup>2</sup>
Order No., female ⊕ right, gold	1566330000		1566350000	1566360000
Order No., female ⊕ right, tin	1566650000	1566660000	1566670000	1566680000
Order No., female ⊕ left, gold		1566420000	1566430000	1566440000
Order No., female ⊕ left, tin	1566730000	1566740000	1566750000	1566760000
Order No., male ⊕ right, gold	1566370000		1566390000	1566400000
Order No., male ⊕ right, tin		1566700000	1566710000	1566720000
Order No., male ⊕ left, gold	1566450000		1566470000	1566480000
Order No., male ⊕ left, tin			1566790000	1566800000

## Inserts

### HDD series

Series	HDD - size 3	HDD - size 4	HDD - size 6
No. of poles	24 + ⊕	42 + ⊕	72 + ⊕
Connection	crimp	crimp	crimp



Rated current	10 A	10 A	10 A
Rated voltage	250 V	250 V	250 V
Nominal voltage to UL/CSA	600 V	600 V	600 V
Clamping range	0.14 – 2.5 mm <sup>2</sup>	0.14 – 2.5 mm <sup>2</sup>	0.14 – 2.5 mm <sup>2</sup>
Order No., female	1651160000	1651180000	1651200000
Order No., male	1651150000	1651170000	1651190000

Series	HDD - size 8	HDD - size 10	HDD - size 12
No. of poles	108 + ⊕	144 + ⊕	216 + ⊕
Connection	crimp	crimp	crimp



Rated current	10 A	10 A	10 A
Rated voltage	250 V	250 V	250 V
Nominal voltage to UL/CSA	600 V	600 V	600 V
Clamping range	0.14 – 2.5 mm <sup>2</sup>	0.14 – 2.5 mm <sup>2</sup>	0.14 – 2.5 mm <sup>2</sup>
Order No., female	1651220000	1651200000 (1-72)	1651220000 (1-108)
Order No., female		1651260000 (73-144)	1651300000 (109-216)
Order No., male	1651210000	1651190000 (1-72)	1651210000 (1-108)
Order No., male		1651240000 (73-144)	1651280000 (109-216)

### HVE series

Series	HVE - size 4	HVE - size 6	HVE - size 8
No. of poles	3 + 2 + ⊕	6 + 2 + ⊕	10 + 2 + ⊕
Connection	tension clamp	tension clamp	tension clamp



Rated current	16 A	16 A	16 A
Rated voltage	830 V	830 V	830 V
Nominal voltage to UL/CSA	600 V	600 V	600 V
Clamping range	0.5 – 2.5 mm <sup>2</sup>	0.5 – 2.5 mm <sup>2</sup>	0.5 – 2.5 mm <sup>2</sup>
Order No., female	1896920000	1896940000	1896960000
Order No., male	1896930000	1896950000	1896970000

Series	HVE - size 4	HVE - size 6	HVE - size 8
No. of poles	3 + 2 + ⊕	6 + 2 + ⊕	10 + 2 + ⊕
Connection	screw	screw	screw



Rated current	16 A	16 A	16 A
Rated voltage	830 V	830 V	830 V
Nominal voltage to UL/CSA	600 V	600 V	600 V
Clamping range	0.5 – 2.5 mm <sup>2</sup>	0.5 – 2.5 mm <sup>2</sup>	0.5 – 2.5 mm <sup>2</sup>
Order No., female	1651320000	1651340000	1651360000
Order No., male	1651310000	1651330000	1651350000

**MixMate series**

Series	S 4 - size 3	S 4/0 - size 6	S 6/12 - size 6	S 6/6 - size 8
No. of poles	4 + ⊕	4 + 0 + ⊕	6 + 12 + ⊕	6 + 6 + ⊕
Connection	axial screw	axial screw	screw/axial screw	screw/axial screw

Rated current	65 A	80 A	48 A/16 A	100 A/16 A
Rated voltage	1000 V	830 V	1000 V/400 V	630 V/400 V
Nominal voltage to UL/CSA	600 V	600 V	600 V	600 V
Clamping range	2.5 – 10 mm <sup>2</sup>	1.5 – 16 mm <sup>2</sup>	2.5 – 10 mm <sup>2</sup> /0.5 – 2.5 mm <sup>2</sup>	16 – 35 mm <sup>2</sup> /0.5 – 2.5 mm <sup>2</sup>
Order No., female	1789980000	1789970000	1790010000	1790020000
Order No., male	1789990000	1789960000	1790000000	1790030000

**HEE series**

Series	HEE - size 3	HEE - size 4	HEE - size 6	HEE - size 8
No. of poles	10 + ⊕	18 + ⊕	32 + ⊕	46 + ⊕
Connection	crimp	crimp	crimp	crimp

  

Rated current	16 A	16 A	16 A	16 A
Rated voltage	500 V	500 V	500 V	500 V
Nominal voltage to UL/CSA	600 V	600 V	600 V	600 V
Clamping range	0.5 – 4 mm <sup>2</sup>	0.5 – 4 mm <sup>2</sup>	0.5 – 4 mm <sup>2</sup>	0.5 – 4 mm <sup>2</sup>
Order No., female	1826840000	1826820000	1826800000	1826780000
Order No., male	1826830000	1826810000	1826790000	1826770000

**HQ series**

Series	HQ - size 1	HQ
No. of poles	5 + ⊕	8 + ⊕
Connection	crimp	crimp

Rated current	16 A	16 A
Rated voltage	400 V / 250 V Pol-PE	500 V
Nominal voltage to UL/CSA	600 V	600 V
Clamping range	0.5 – 4 mm <sup>2</sup>	0.5 – 4 mm <sup>2</sup>
Order No., female	1912460000	1919980000
Order No., male	1912440000	1919970000

**HSB series**

Series	HSB - size 6	HSB - size 10
No. of poles	6 + ⊕	12 + ⊕
Connection	screw	screw





  

  

Rated current	35 A	35 A
Rated voltage	400 V	400 V
Nominal voltage to UL/CSA	600 V	600 V
Clamping range	0.5 – 6 mm <sup>2</sup> *	0.5 – 6 mm <sup>2</sup> *
Order No., female	1498900000	1498900000
Order No., female (7 – 12)		1499000000
Order No., male	1498700000	1498700000
Order No., male (7 – 12)		1498800000

\*max. with wire end ferrule 4 mm<sup>2</sup>





ConCept modules

Series	CM high-voltage	CM-3 HV	CM-3	CM-HE
No. of poles	2	3	3	4
Connection	screw	crimp	crimp	crimp
				
Rated current	82 A	57 A	40 A	25 A
Rated voltage	1000 V	1000 V	630 V	630 V
Nominal voltage to UL/CSA	600 V	600 V	600 V	600 V
Clamping range	4 – 16 mm <sup>2</sup>	1.5 – 10 mm <sup>2</sup>	1.5 – 10 mm <sup>2</sup>	0.5 – 4 mm <sup>2</sup>
Order No., female	1828410000*	1862060000	1758370000	1861900000
Order No., female, with release lever	1828400000	1862070000	1879040000	1758350000
Order No., male	1828390000*	1862080000	1758360000	1861920000
Order No., male, with release lever	1828380000	1862000000	1879030000	1758340000

\*with separate PE connection

Series	CM-4	CM-5	CM-10	CM-20
No. of poles	4	5	10	20
Connection	tension clamp	crimp	crimp	crimp
				
Rated current	14 A	20 A	10 A	4 A
Rated voltage	400 V	250 V	250 V	100 V
Nominal voltage to UL/CSA	600 V	600 V	600 V	600 V
Clamping range	0.5 – 2.5 mm <sup>2</sup>	0.75 – 4 mm <sup>2</sup>	0.14 – 2.5 mm <sup>2</sup>	0.08 – 0.52 mm <sup>2</sup>
Order No., female	1730130000	1758390000	1758410000	
Order No., female, with release lever		1879010000	1862030000	1758430000
Order No., male	1730120000	1758380000	1758400000	
Order No., male, with release lever		1879020000	1862050000	1758420000

Series	CM pneumatic	CM pneumatic	CM pneumatic	CM pneumatic
Inputs/outputs	1	1	2	2
				
Operating pressure	10 bar	10 bar	10 bar	10 bar
Hose diameter (outside)	8 mm	8 mm	8 mm	8 mm
Hose diameter (inside)	2.5 mm	4 mm	2.5 mm	4 mm
Order No., female	1894780000	1894720000	1894750000	1894760000
Order No., male	1894730000	1894740000	1894770000	1894710000

Series	CM BUS 4	CM BUS 2 PDP
No. of poles	4 + ⊕	2 + ⊕
Connection	screw	screw
		
Rated current	1 A	1 A
Rated voltage	30 V	30 V
Transmission rate	max. 1.5 Mbps	max. 1.5 Mbps
Clamping rang	0.08 – 1.5 mm <sup>2</sup>	to Profibus DP standard
Order No., female	1814300000	1806030000
Order No., male	1814310000	1806060000

### ConCept System Bus

Series	CSB	CSB
No. of poles	1 + 4 + ⊕	4 + 4 + ⊕
Connection	crimp	crimp



The product illustrated comprises the order Nos. given below.

Rated current	20 A/10 A	20 A/10 A
Rated voltage	400 V/50 V	400 V/50 V
No. of contacts	1 + Shield	4 + Shield
Clamping range	0.75 – 4 mm <sup>2</sup> /0.14 – 2.5 mm <sup>2</sup>	0.75 – 4 mm <sup>2</sup> /0.14 – 2.5 mm <sup>2</sup>
Order No., female	1908540000	1908500000
Order No., male	1908520000	1908480000
Plastic body, order No., female	1908490000	1908490000
Plastic body, order No., male	1908530000	1908530000
Earthing connection, order No.	1908510000	1908510000

### ConCept frames

Series	CF 6	CF 10
Size	3	4
No. of modules	2	3



Order No., female	1758450000	1758470000
Order No., male	1758440000	1758460000

Series	CF 16	CF 24
Size	6	8
No. of modules	5	7



Order No., female	1758490000	1758510000
Order No., male	1758480000	1758500000

Series	2 x CF 16	2 x CF 24
Size	10	12
No. of modules	10	14



Order No., female	1758490000 (1-16)	1758510000 (1-24)
Order No., female	1758520000 (17-32)	1758550000 (25-48)
Order No., male	1758480000 (1-16)	1758500000 (1-24)
Order No., male	1758530000 (17-32)	1758540000 (25-48)

### ModuFlex C

Series	C-CR	C-MW	MOFU	C-MH/ZE*
	Coupling frame	Mounting bracket	Mounting foot	Module release tool and strain relief



Order No.	1746060000	1746070000	0495660000	1752970000
-----------	------------	------------	------------	------------

\*not suitable for CM-3HV modules

### Assembly principle

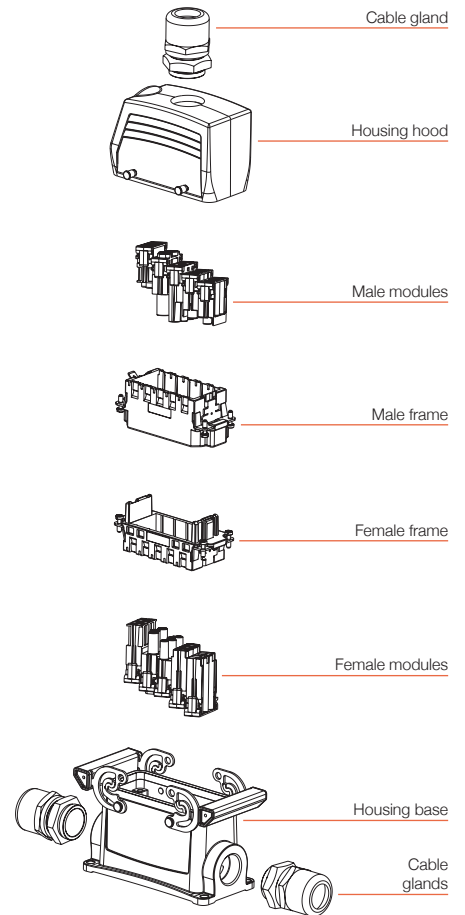

Housing hoods – metric

Side cable entry

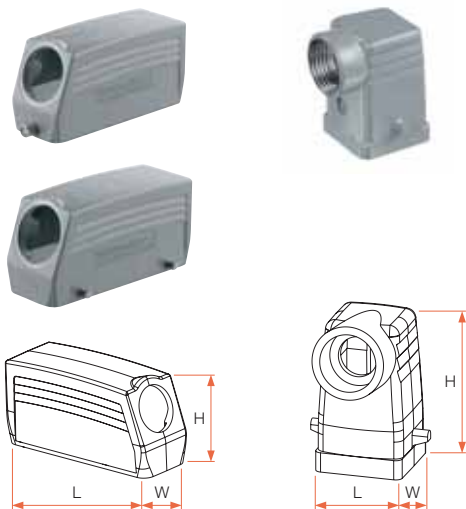

Standard housing						
Size	L	W	H	M	Order No. (1 lock)	Order No. (2 locks)
1	26.7	26.7	49.2	20	1788510000 <sup>1</sup>	
	26.7	26.7	49.2	20	1788810000	
2	63	29.5	68	20	1788860000	
	60	43	52	20	1805930000	
3	60	43	52	25	1788090000	
	73	43	52	20		1787560000
4	73	43	52	25	1787580000	1787550000
	79	29.5	58	25	1788740000	
5	93.3	43	61	25	1788200000	1788180000
	93.3	43	61	32	1804640000	
6	93.3	43	61	40		1900500000
	82	56	75	25		1787960000
7	82	56	75	32		1787950000
	120	43	61	25	1787800000	1787760000
8	120	43	61	32	1787790000	1787750000
	94	83	79	32	1788550000	
9	94	83	79	32	1788420000	1788400000
	132	90	94	32	1788320000	
12	132	90	94	40	1788310000	
	132	90	94	50	1788300000	

High housing						
Size	L	W	H	M	Order No. (1 lock)	Order No. (2 locks)
2	63	29.5	67.5	20	1788860000	
	63	29.5	67.5	25	1788850000	
3	60	43	72	25	1787480000	
	60	43	72	32	1787470000	
	60	43	72	40	1857640000	
4	73	43	72	25	1787280000	1787240000
	73	43	72	32	1787270000	1787230000
5	79	29.5	72.3	20	1788680000	
	79	29.5	72.3	25	1788690000	
6	93.3	43	76	25	1787050000	1787010000
	93.3	43	76	32	1787040000	1787000000
8	93.3	43	76	40	1804650000	
	120	43	76	25		1786780000
8	120	43	76	32	1786810000	1786770000
	120	43	76	40	1804610000	1809630000

<sup>1</sup> plastic

Top cable entry

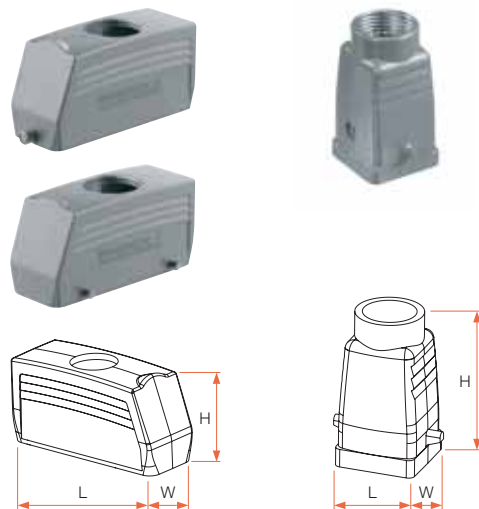

Standard housing						
Size	L	W	H	M	Order No. (1 lock)	Order No. (2 locks)
1	26.7	26.7	50	20	1788520000 <sup>1</sup>	
	26.7	26.7	50	20	1788820000	
2	63	29.5	54	20	1788620000	
	63	29.5	54	25	1788610000	
3	60	43	52	20	1788120000	
	60	43	52	25	1788110000	
4	73	43	52	20		1787600000
	73	43	52	25	1787620000	
5	79	29.5	58	25	1788750000	
	93.3	43	61	25	1788230000	1788210000
6	93.3	43	61	32	1804630000	
	82	56	75	32		1787990000
7	82	56	75	25	1787860000	1787820000
	120	43	61	25	1787850000	1787810000
8	120	43	61	32	1787850000	1787810000
	95	83	79	32	1788560000	
9	95	83	79	32	1788450000	1788430000
	132	90	94	32	1788350000	
10	132	90	94	40	1788340000	
	132	90	94	50	1788330000	

High housing						
Size	L	W	H	M	Order No. (1 lock)	Order No. (2 locks)
3	60	43	72	25	1787500000	
	60	43	72	32	1787490000	
4	73	43	72	25	1787340000	1787300000
	73	43	72	32	1787330000	1787290000
5	79	29.5	72	20	1788710000	
	79	29.5	72	25	1788700000	
6	93.3	43	76	25		1787070000
	93.3	43	76	32	1787100000	1787060000
8	120	43	76	25	1786870000	
	120	43	76	32	1786860000	1786830000

Housing base parts – metric

Bulkhead housing

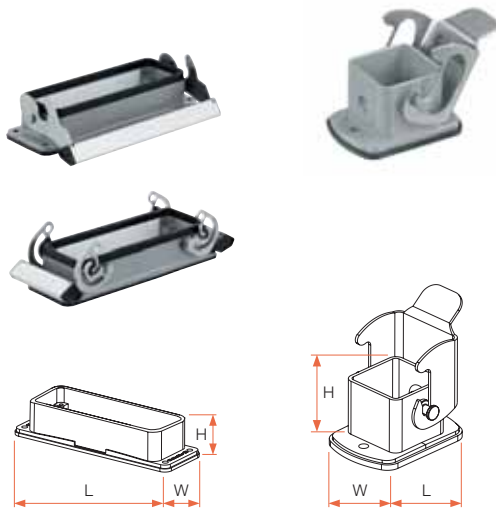

Standard housing

Size	L	W	H	Order No. (1 lock)	Order No. (2 locks)
1	28	30	23	1652410000 <sup>1</sup>	
	28	30	24	1497600000	
2	84	32	26	1664040000	
	84	32	26	1664060000	
3	82	47	29	1202100000	
	82	47	29	1202500000 <sup>2</sup>	
4	95	47	29	1206100000	1205000000
	95	47	29	1206500000 <sup>2</sup>	
5	98	33	26	1664920000	
	98	33	26	1664940000 <sup>2</sup>	
6	115	47	29	1209700000	
	115	47	29	1210100000 <sup>2</sup>	1208600000
7	102	56	25		1665860000
	143	47	29	1213900000	1212400000
8	143	47	29	1214300000 <sup>2</sup>	
	127	89	38	1666740000	
9	127	89	38	1666750000 <sup>2</sup>	
	127	89	38	1219500000	1217800000
10	127	89	38	1219800000 <sup>2</sup>	
	168	97	41.5	1222900000 <sup>2</sup>	

Base housing (2 cable entries except size 1)

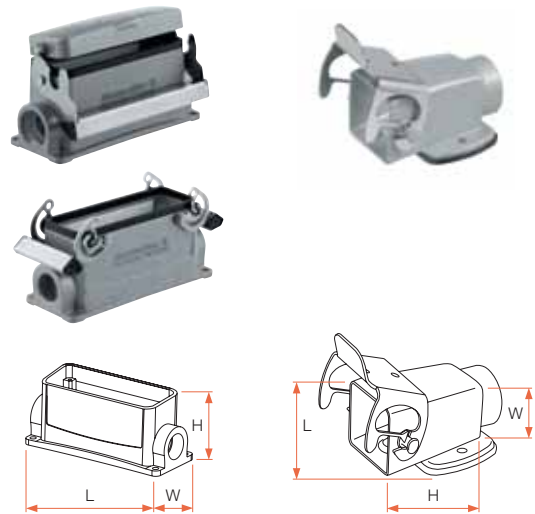

Standard housing

Size	L	W	H	M	Order No. (1 lock)	Order No. (2 locks)
1	40	28	40.5	20	1788530000 <sup>1</sup>	
	40	28	40.5	20	1788830000	
2	80	50	57	20	1788640000	
	80	50	57	20	1788660000 <sup>2</sup>	
	80	50	57	25	1788630000	
	82	50	57	25	1788650000 <sup>2</sup>	
3	82	54.5	54	20	1788140000	
	82	54.5	54	20	1788170000 <sup>2</sup>	
	82	54.5	54	25	1788130000	
	82	54.5	54	25	1788160000 <sup>2</sup>	
4	92.5	53.5	57	20	1901620000	
	92.5	53.5	57	20	1901570000 <sup>2</sup>	1787640000
	92.5	53.5	57	25	1901640000	1787630000
	96	50	57	20	1788770000	
5	96	50	57	20	1788790000 <sup>2</sup>	
	96	50	57	25	1788760000	
	96	50	57	25	1788780000 <sup>2</sup>	
6	117	56.5	64	25	1788250000	
	117	56.5	64	25	1788270000 <sup>2</sup>	1788240000
7	106	64.5	75	25		1788040000
8	144	57.5	64	25	1787880000	
	144	57.5	64	25	1787900000 <sup>2</sup>	1787870000
9	126	92.5	79	32	1788570000	
10	126	92.5	79	32	1788470000	
	126	92.5	79	32	1788490000 <sup>2</sup>	1788460000
12	138	120	100	32	1788370000	
	138	120	100	32	1788390000 <sup>2</sup>	
	138	120	100	40	1788360000	

High housing

Size	L	W	H	M	Order No. (1 lock)	Order No. (2 locks)
3	82	55.5	74	25	1787520000	
	82	55.5	74	25	1787540000 <sup>2</sup>	
	82	55.5	74	32	1787510000	
4	92.5	55.5	74	25	1787420000 <sup>2</sup>	1787350000
	92.5	55.5	74	32	1787370000	
	92.5	55.5	74	32	1787410000 <sup>2</sup>	1787360000
6	117	56.5	84	25	1787140000	
	117	56.5	84	25	1787180000 <sup>2</sup>	1787120000
	117	56.5	84	32	1804660000	
	117	56.5	84	32	1787170000 <sup>2</sup>	1787110000
8	144	57.5	84	25	1786910000	
	144	57.5	84	25	1786950000 <sup>2</sup>	1786890000
	144	57.5	84	32	1786900000	
	144	57.5	84	32	1786940000 <sup>2</sup>	1786880000

<sup>1</sup> plastic <sup>2</sup> with cover

Housing hoods – PG thread

Side cable entry

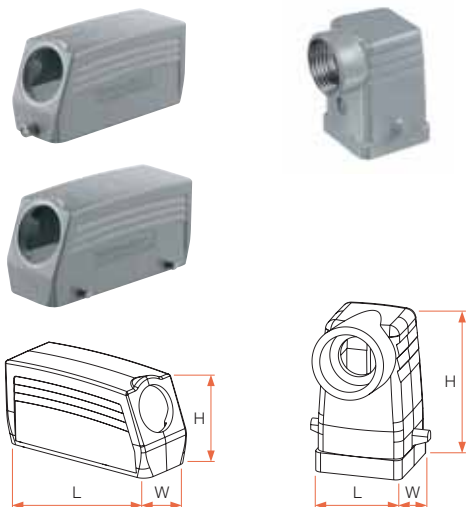

Top cable entry

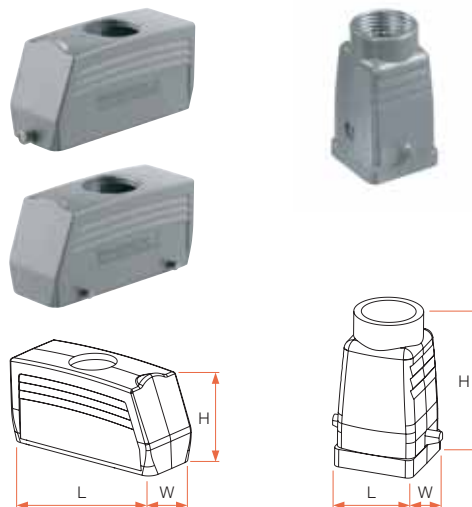

Standard housing						
Size	L	W	H	PG	Order No. (1 lock)	Order No. (2 locks)
1	26.7	26.7	49,2	11	1652400000 <sup>1</sup>	
	26.7	26.7	49,2	11	1652480000	
2	63	29.5	54	16	1663810000	
	60	43	52	13,5	1670530000	
3	60	43	52	16	1652520000	
	73	43	52	16	1655210000	1654070000
4	73	43	52	21		1654090000
	79	29.5	58	16	1664690000	
6	93.3	43	61	21	1657850000	1656480000
	82	56	75	21		1665670000
7	82	56	75	29		1665690000
	120	43	61	21	1662390000	1661230000
8	120	43	61	29	1662410000	1661240000
	94	83	79	29	1666710000	
10	94	83	79	29	1667120000	1666840000
	132	90	94	29	1650850000	
12	132	90	94	36	1650860000	
	132	90	94	42	1670470000	

High housing						
Size	L	W	H	PG	Order No. (1 lock)	Order No. (2 locks)
2	63	29.5	68	16	1663850000	
	63	29.5	68	21	1663870000	
3	60	43	72	21	1652560000	
	60	43	72	29	1652580000	
4	73	43	72	21	1655250000	1654150000
	73	43	72	29	1655270000	1654170000
5	79	29.5	72	16	1664730000	
	79	29.5	72	21	1664750000	
6	93.3	43	76	21	1657890000	1656520000
	93.3	43	76	29	1657910000	1656540000
8	120	43	76	21	1662470000	1661300000
	120	43	76	29	1662490000	1661320000

<sup>1</sup> plastic

Standard housing						
Size	L	W	H	PG	Order No. (1 lock)	Order No. (2 locks)
1	26.7	26.7	50	11	1652380000 <sup>1</sup>	
	26.7	26.7	50	11	1652470000	
2	63	29.5	54	16	1663930000	
	60	43	52	13.5	1670500000	
3	60	43	52	16	1652640000	
	73	43	52	16	1655320000	1654220000
4	73	43	52	21		1816420000
	79	29.5	58	16	1664810000	
6	93.3	43	61	21	1657960000	1656590000
	82	56	77	21		1665790000
7	82	56	77	29		1665810000
	120	43	61	21	1662540000	1661370000
8	120	43	61	29	1662550000	1661380000
	94	83	79	29	1666730000	
10	94	83	79	29		1666870000
	132	90	94	29	1650980000	
12	132	90	94	36	1651000000	

High housing						
Size	L	W	H	PG	Order No. (1 lock)	Order No. (2 locks)
2	63	29.5	68	21	1663990000	
	60	43	72	21	1652680000	
3	60	43	72	29	1652700000	
	73	43	72	21	1655360000	
4	73	43	72	29	1655380000	1654320000
	79	29.5	72	21	1664870000	
6	93.3	43	76	21		1656630000
	93.3	43	76	29	1658020000	1656650000
8	120	43	76	21	1662610000	1661440000
	120	43	76	29	1662630000	1661460000

Housing base parts – PG

Bulkhead housing

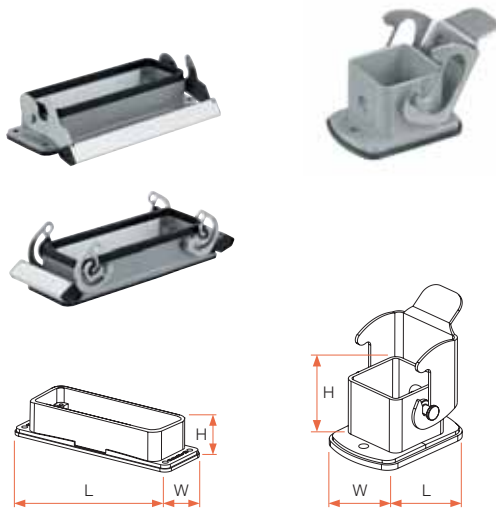

Standard housing					
Size	L	W	H	Order No. (1 lock)	Order No. (2 locks)
1	28	30	23	1652410000 <sup>1</sup>	
	28	30	24	1497600000	
2	84	32	26	1664040000	
	84	32	26	1664060000 <sup>2</sup>	
3	82	47	29	1202100000	
	82	47	29	1202500000 <sup>2</sup>	
4	95	47	29	1206100000	
	95	47	29	1206500000 <sup>2</sup>	1205000000
5	98	33	26	1664920000	
	98	33	26	1664940000 <sup>2</sup>	
6	115	47	29	1209700000	
	115	47	29	1210100000 <sup>2</sup>	1208600000
7	102	56	25		1665860000
8	143	47	29	1213900000	
	143	47	29	1214300000 <sup>2</sup>	1212400000
9	127	89	38	1666740000	
	127	89	38	1666750000 <sup>2</sup>	
10	127	89	38	1219500000	1217800000
	127	89	38	1219800000 <sup>2</sup>	
12	168	97	41.5	1222900000 <sup>2</sup>	

<sup>1</sup> plastic <sup>2</sup> with cover <sup>3</sup> 1 cable entry only, PG 29

Base housing (2 cable entries except size 1)

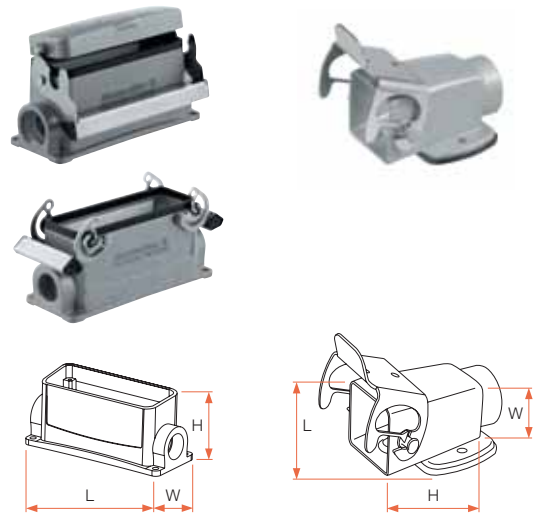

Standard housing						
Size	L	W	H	PG	Order No. (1 lock)	Order No. (2 locks)
1	40	28	40.5	11	1652440000 <sup>1</sup>	
	40	28	40.5	11	1652490000	
2	80	50	57	16	1664190000	
	80	50	57	16	1664420000 <sup>2</sup>	
3	82	54.5	54	16	1652760000	
	82	54.5	54	16	1652990000 <sup>2</sup>	
4	92.5	53.5	57	16	1655470000	
	92.5	53.5	57	16	1655680000 <sup>2</sup>	1654380000
5	96	50	57	16	1665070000	
	96	50	57	16	1665300000 <sup>2</sup>	
6	117	56.5	64	21	1658120000	
	117	56.5	64	21	1658330000 <sup>2</sup>	1656730000
7	106	64.5	75	21		1665980000
8	144	57.5	64	21	1662720000	
	144	57.5	64	21	1214500000 <sup>2</sup>	1661520000
9	126	92.5	79	29	1666770000 <sup>3</sup>	
10	126	92.5	79	29		1666920000
	126	92.5	79	36		1902640000
12	138	120	100	29	1667560000 <sup>2</sup>	

High housing						
Size	L	W	H	PG	Order No. (1 lock)	Order No. (2 locks)
3	82	55.5	74	21	1652840000	
4	92.5	55.5	74	21		1654450000
6	117	56.5	84	21		1656810000
	117	56.5	84	29		1656840000
8	144	57.5	84	21		1661590000
	144	57.5	84	29	1663040000 <sup>2</sup>	1661630000

Conversion table

PG	Clamping range	M	Clamping range	PG	Clamping range	M	Clamping range	PG	Clamping range	M	Clamping range
29	24-28	40	22-32	21	11.5-15.5	32	13-20	13.5	9-13	32	13-20
		40	20-26			25	13-18			25	13-18
		32	18-25			25	9-16			25	9-16
29	20-25	40	22-32	16	11.5-15.5	20	10-14	11	7-10.5	20	10-14
		40	20-26			20	6-12			20	6-12
		32	18-25			20	5-9			20	5-9
29	17-20.5	40	20-26	16	9-13	32	13-20	11	5-8	25	9-16
		32	18-25			25	13-18			20	10-14
		32	13-20			20	10-14			20	6-12
		25	13-18			20	6-12			20	5-9
21	14-18	32	18-25	16	9-13	32	13-20	11	5-8	20	6-12
		32	13-20			25	13-18			20	5-9
		25	13-18			25	9-16				
		25	9-16			20	10-14				
		20	10-14			20	6-12				
		20	6-12			20	5-9				

### Housing hoods

#### Side cable entry

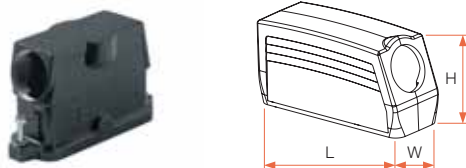

shockproof					
Size	L	W	H	M	Order No.
3	96	54	70	25	1827390000
4	110	54	70	32	1827350000
6	130	54	80	32	1827290000
8	156	54	90	40	1827240000
8XXL	184	57	120	50	1827190000
12XXL	182	92	135	40	1827140000

EMC					
Size	L	W	H	M	Order No.
3	96	54	70	25	1827370000
4	110	54	70	32	1827330000
6	130	54	80	32	1827260000
8	156	54	90	40	1827220000
8XXL	184	57	120	50	1827160000
12XXL	182	92	135	40	1827120000

#### Top cable entry

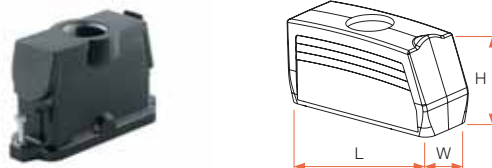

shockproof					
Size	L	W	H	M	Order No.
1	52	32	54	20	1827440000
3	96	54	70	25	1827400000
4	110	54	70	32	1827360000
6	130	54	80	32	1827310000
8	156	54	90	40	1827250000
8XXL	184	57	120	50	1827200000
12XXL	182	92	135	50	1827150000

EMC					
Size	L	W	H	M	Order No.
1	51	31.2	56	20	1827420000
3	96	54	70	25	1827380000
4	110	54	70	32	1827340000
6	130	54	80	32	1827280000
8	156	54	90	40	1827210000
8XXL	184	57	120	50	1827170000
12XXL	182	92	135	50	1827130000

### Housing base parts

#### Bulkhead housing

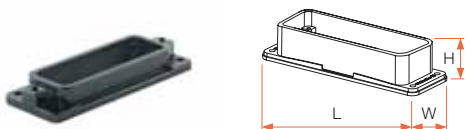

shockproof				
Size	L	W	H	Order No.
1	51	32	22	1827580000 (M4)
	96	56	22	1827560000 (M4)
3	96	60	22	1828590000 (M6)
	96	60	22	1828550000 (M6D)
4	109	56	22	1827540000 (M4)
	109	60	22	1828580000 (M6)
	109	60	22	1828530000 (M6D)
6	129.5	56	22	1827520000 (M4)
	129.5	60	22	1828570000 (M6)
	129.5	60	22	1828510000 (M6D)
8	156	56	22	1827500000 (M4)
	156	60	22	1828560000 (M6)
	156	60	22	1828490000 (M6D)
8XXL	184	57	29	1827480000 (M4)
	184	57	29	1846020000 (high)
12XXL	182.5	92	109	1827460000 (M4)
	182.5	92	109	1846000000 (high)

EMC				
Size	L	W	H	Order No.
1	50.8	31.6	26.1	1827570000 (M4)
3	96	56	22	1827550000 (M4)
	96	60	22	1828540000 (M6)
4	109	56	22	1827530000 (M4)
	109	60	22	1828520000 (M6)
6	129.5	56	22	1827510000 (M4)
	129.5	60	22	1828500000 (M6)
8	156	56	22	1827490000 (M4)
	156	60	22	1828480000 (M6)
8XXL	184	57	29	1827470000 (M4)
	184	57	29	1846010000 (high)
12XXL	182.5	92	109	1827450000 (M4)
	182.5	92	109	1845980000 (high)

#### Base housing

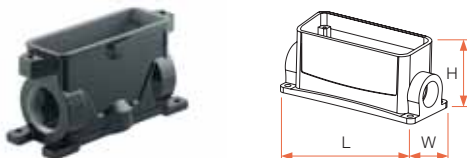

shockproof					
Size	L	W	H	M	Order No.
1	51	31	48	20	1827680000
3	90	56	80	25	1827660000
4	103	56	80	32	1827640000
6	123.5	56	80	32	1827620000
8	150	56	80	40	1827600000

EMC					
Size	L	W	H	M	Order No.
1	51	31	48	20	1827670000
3	90	56	80	25	1827650000
4	103	56	80	32	1827630000
6	123.5	56	80	32	1827610000
8	150	56	80	40	1827590000

Cable glands



Thread	Order No.	Clamping range	Order No.	Clamping range	Order No.	Clamping range	Order No.	Clamping range
M 20	1909700000	10 – 14 mm <sup>2</sup>	1778370000	10 – 12 mm <sup>2</sup>	1772300000	6 – 12 mm <sup>2</sup>	1772220000	6 – 12 mm <sup>2</sup>
M 25	1909710000	13 – 18 mm <sup>2</sup>	1778350000	15 – 17 mm <sup>2</sup>	1909870000	11 – 17 mm <sup>2</sup>	1909920000	11 – 17 mm <sup>2</sup>
M 32	1909720000	18 – 25 mm <sup>2</sup>	1778340000	24 – 26 mm <sup>2</sup>	1909880000	15 – 21 mm <sup>2</sup>	1909930000	15 – 21 mm <sup>2</sup>
M 40	1909730000	22 – 32 mm <sup>2</sup>	1778330000	28 – 30 mm <sup>2</sup>	1909890000	19 – 28 mm <sup>2</sup>	1909940000	19 – 28 mm <sup>2</sup>
M 50	1909740000	30 – 38 mm <sup>2</sup>	1778310000	39 – 41 mm <sup>2</sup>	1909900000	27 – 38 mm <sup>2</sup>	1909950000	27 – 38 mm <sup>2</sup>
PG 11	1909780000	5 – 10 mm <sup>2</sup>	0260700000	8 – 10 mm <sup>2</sup>	1568990000	5 – 10 mm <sup>2</sup>	1569080000	5 – 10 mm <sup>2</sup>
PG 13.5	1909790000	6 – 12 mm <sup>2</sup>	0260800000	10 – 12 mm <sup>2</sup>	1569000000	6 – 12 mm <sup>2</sup>	1569090000	6 – 12 mm <sup>2</sup>
PG 16	1909800000	10 – 14 mm <sup>2</sup>	0261400000	12 – 14 mm <sup>2</sup>	1569010000	10 – 14 mm <sup>2</sup>	1569100000	10 – 14 mm <sup>2</sup>
PG 21	1909810000	13 – 18 mm <sup>2</sup>	0260900000	15 – 17 mm <sup>2</sup>	1569020000	13 – 18 mm <sup>2</sup>	1569110000	13 – 18 mm <sup>2</sup>
PG 29	1909820000	18 – 25 mm <sup>2</sup>	0261000000	24 – 26 mm <sup>2</sup>	1569030000	18 – 25 mm <sup>2</sup>	1569120000	18 – 25 mm <sup>2</sup>
PG 36	1909830000	22 – 32 mm <sup>2</sup>	0497600000	33 – 35 mm <sup>2</sup>	1569040000	22 – 32 mm <sup>2</sup>	1569130000	22 – 32 mm <sup>2</sup>
PG 42	1909840000	30 – 38 mm <sup>2</sup>	0497700000	41 – 43 mm <sup>2</sup>	1569050000	30 – 38 mm <sup>2</sup>	1569140000	30 – 38 mm <sup>2</sup>



Thread	Order No.	Clamping range	Order No.	Order No.	Order No.
M 20	1921720000	7 – 13 mm <sup>2</sup>	1777940000	1776910000	1777740000
M 25	1921740000	11.5 – 15 mm <sup>2</sup>	1777950000	1776900000	1777750000
M 32	1921760000	13 – 19 mm <sup>2</sup>	1777960000	1776940000	1777760000
M 40	1921770000	21 – 27 mm <sup>2</sup>	1777970000	1776950000	1777770000
M 50			1777980000	1776960000	1777780000
PG 11	1656390000	6.5 – 12 mm <sup>2</sup>	1719460000	0294860000	0294800000
PG 13.5	1656400000	6.5 – 13 mm <sup>2</sup>	1719470000	0294960000	0294900000
PG 16	1656410000	6.5 – 16 mm <sup>2</sup>	1719480000	0295060000	0295000000
PG 21	1656420000	9 – 20 mm <sup>2</sup>	1719490000	0295160000	0295100000
PG 29	1656430000	17 – 28 mm <sup>2</sup>	1719500000	0501160000	0501100000
PG 36	1656440000	23 – 34 mm <sup>2</sup>	1719510000	0501260000	0501200000
PG 42	1656450000	29 – 40 mm <sup>2</sup>	1719520000	0501360000	0501300000

\*To be used as inserts for hoods fitted with sleeves only \*\*Can be ordered as accessory for base housing





### HA 3 kits

3 poles, 250 V, 10 A, size 1						
comprising:	female insert	male insert	hood	cable glands	bulkhead housing	bulkhead housing, 90°
						
<b>Metal housing</b>					<b>Kit</b>	<b>Kit</b>
					Order No.	Order No.
M20					1802470000	1802450000
PG11					1712560000	1712580000
						
<b>Plastic housing</b>					<b>Kit</b>	<b>Kit</b>
					Order No.	Order No.
M20					1802460000	
PG11					1712570000	1712630000







### HA 4 kits

4 poles, 250 V, 16 A, size 1						
comprising:	female insert	male insert	hood	cable glands	bulkhead housing	bulkhead housing, 90°
						
<b>Metal housing</b>					<b>Kit</b>	<b>Kit</b>
					Order No.	Order No.
M20					1802440000	1802700000
PG11					1712590000	1712610000
						
<b>Plastic housing</b>					<b>Kit</b>	<b>Kit</b>
					Order No.	Order No.
M20					1802430000	1802720000
PG11					1712600000	1712650000







### HE 6 kits

6 poles, 500 V, 16 A, size 3						
comprising:	female insert	male insert	bulkhead housing	cable glands	hood, top cable entry	hood, side cable entry
						
<b>Metal housing</b>					<b>Kit</b>	<b>Kit</b>
					Order No.	Order No.
M20					1802740000	1802730000
PG16					1712660000	1712460000







### HE 10 kits

10 poles, 500 V, 16 A, size 4						
comprising:						
female insert	male insert	bulkhead housing	cable glands	hood, top cable entry	hood, side cable entry	
						
Metal housing				Kit	Kit	
				Order No.	Order No.	
M25				1802410000	1802420000	
PG16				1712670000	1712510000	





### HE 16 kits

16 poles, 500 V, 16 A, size 6						
comprising:						
female insert	male insert	bulkhead housing	cable glands	hood, top cable entry	hood, side cable entry	
						
Metal housing				Kit	Kit	
				Order No.	Order No.	
M25				1802390000	1802400000	
PG21				1712680000	1712520000	







### HE 24 kits

24 poles, 500 V, 16 A, size 8						
comprising:						
female insert	male insert	bulkhead housing	cable glands	hood, top cable entry	hood, side cable entry	
						
Metal housing				Kit	Kit	
				Order No.	Order No.	
M32				1802480000	1802380000	
PG21				1712690000	1712530000	

### HE 32 kits

32 poles, 500 V, 16 A, size 10						
comprising:						
female insert	male insert	bulkhead housing	cable glands			hood, side cable entry
						
Metal housing						Kit
						Order No.
M32						1802370000
PG29						1712540000

### HE 48 kits

48 poles, 500 V, 16 A, size 12						
comprising:						
female insert	male insert	bulkhead housing	cable glands	hood, top cable entry	hood, side cable entry	
						
Metal housing				Kit	Kit	
				Order No.	Order No.	
M40				1802360000		
PG29					1712550000	

**Crimp contacts**

**HD/HDD/CM-10**



Crimping range 0.14 – 2.5 mm<sup>2</sup>, Stripping length 8 mm

		Silver surface		Gold surface	
Conductor cross-section	AWG	Order No., female	Order No., male	Order No., female	Order No., male
0.14 – 0.37 mm <sup>2</sup>	26-22	1651570000	1651520000	1651670000	1651620000
0.5 mm <sup>2</sup>	20	1651580000	1651530000	1651680000	1651630000
0.75 – 1 mm <sup>2</sup>	18	1601760000	1601750000	1601690000	1601640000
1.5 mm <sup>2</sup>	16	1651600000	1651550000	1651700000	1651650000
2.5 mm <sup>2</sup>	14	1651610000	1651560000	1651710000	1651660000

**HE/HEE/CM-HE**



Crimping range 0.5 – 4 mm<sup>2</sup>, Stripping length 7.5 mm

		Silver surface		Gold surface	
Conductor cross-section	AWG	Order No., female	Order No., male	Order No., female	Order No., male
0.5 mm <sup>2</sup>	18	1201100000	1200500000	1651470000	1651420000
0.75 – 1 mm <sup>2</sup>	16	1201200000	1200600000	1651480000	1651430000
1.5 mm <sup>2</sup>	14	1201300000	1200700000	1651490000	1651440000
2.5 mm <sup>2</sup>	12	1201400000	1200800000	1651500000	1651450000
4 mm <sup>2</sup>		1201500000	1200900000	1651510000	1651460000

**CM-3**



Crimping range 1.5 – 10 mm<sup>2</sup>, Stripping length 10 mm

		Silver surface	
Conductor cross-section	AWG	Order No., female	Order No., male
1.5 mm <sup>2</sup>	16	1698130000	1698120000
2.5 mm <sup>2</sup>	14	1698150000	1698140000
4 mm <sup>2</sup>	12	1682270000	1682260000
6 mm <sup>2</sup>	10	1682290000	1682280000
10 mm <sup>2</sup>	7	1682310000	1682300000

**CM-5**



Crimping range 0.75 – 4 mm<sup>2</sup>, Stripping length 8 mm

		Silver surface	
Conductor cross-section	AWG	Order No., female	Order No., male
0.75 – 1 mm <sup>2</sup>	18	1682350000	1682340000
1.5 mm <sup>2</sup>	16	1682370000	1682360000
2.5 mm <sup>2</sup>	14	1682390000	1682380000
4 mm <sup>2</sup>	12	1682410000	1682400000

### RailMate terminal rail mounting system

Type	HDC RailMate HB 6 Set	HDC RailMate HB 10 Set	HDC RailMate HB 16 Set	HDC RailMate HB 24 Set
Size	3	4	6	8
Order No.	1797500000	1797510000	1797520000	1797530000

Every set consists of: base plate, slider, top bracket, 2 insert holder brackets, insert holder frame

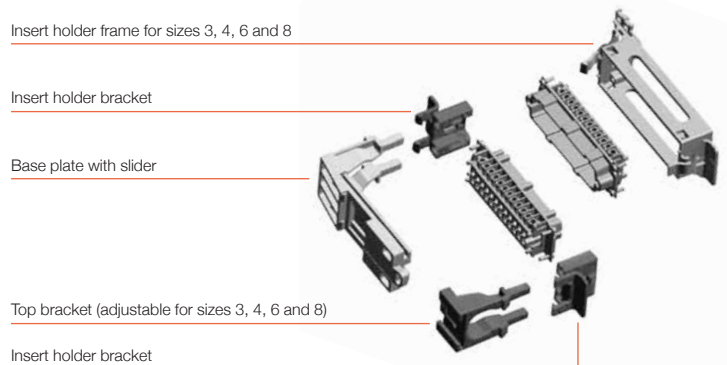

### Crimping tools

CTX CM 1.6/2.5	CTX CM 3.6	CZB 1	HDC-CM-3
for turned contacts: HD, HE, ConCept	for turned contacts: HD, HE, ConCept	for turned contacts: HE, ConCept CM-3	for turned contacts: HE, ConCept CM-3



Crimping range	0.14 – 2.5 mm <sup>2</sup>	4 – 10 mm <sup>2</sup>	0.5 – 4 mm <sup>2</sup>	1.5 – 10 mm <sup>2</sup>
Order No.	9018490000	9018480000	9012710000	1700890000

### Contact removal tools

Removal tool for	HD	HE	ConCept CM-3	ConCept CM-5
------------------	----	----	--------------	--------------



Order No.	1866730000	1866750000	1866710000	1866720000
-----------	------------	------------	------------	------------

# Worldwide activities

- AE UAE**  
**United Arab Emirates**  
 Weidmüller Middle-East  
 P.O. Box 62448  
 Dubai  
 Phone +971 4 3522215, 3523043  
 Fax +971 4 3599950  
 info@weidmueller.ae
- AR Argentina**  
 CPI SA  
 Bauness 2660  
 1431 Buenos Aires  
 Phone +54 11 45238008  
 Fax +54 11 45220546  
 compras@cpi.com.ar
- AT Austria**  
 Weidmüller Ges.m.b.H.  
 Industriezentrum Nö Süd  
 Straße 2, Objekt M2  
 2355 Wiener Neudorf  
 Phone +43 2236 6708-0  
 Fax +43 2236 6708-199  
 office.at@weidmueller.com
- AU Australia**  
 Weidmüller Pty. Ltd.  
 43 Huntingwood Drive  
 Huntingwood,  
 NSW, 2148  
 P.O.Box 6944  
 Blacktown  
 NSW, 2148  
 Phone +61 2 9671-9999  
 Fax +61 2 9671-9911  
 info@weidmuller.com.au  
 www.weidmuller.com.au
- AZ Azerbaijan**  
 West Industries Ltd.  
 Caspian Plaza, 5-th Floor  
 44 J. Jabbarly Str., Baku, Azerbaijan  
 Phone +99412 499 15 15  
 Fax +99412 499 14 93  
 sales@west-i.com
- BA Bosnia-Herzegovina**  
 BH ES Elektrosistem d.o.o.  
 ul. J. Veselinovica 18  
 78000 Banja Luka  
 Bosna  
 Phone +387 51 317500  
 Fax +387 51 317500  
 elsist@inecco.net  
 www.elektrosistem.co.yu
- BE Belgium**  
 Weidmüller Benelux B.V.  
 Ambachtenlaan 11 A  
 3001 Heverlee  
 Phone +32 16 395990  
 Fax +32 16 401051  
 info@weidmueller.be
- BG Bulgaria**  
 Weid-Bul eOOD  
 ul. Nezabravka 33 A,  
 bl. 315/3/10  
 1113 Sofia  
 Phone +359 2 9632560  
 Fax +359 2 9631098  
 weidbul@nat.bg
- BH Bahrain**  
 Khayber Trading Company  
 P.O. Box 1976 Manama,  
 Bahrain  
 Phone +973 17720747  
 Fax +973 17720331  
 khayber@batelco.com.bh
- BR Brazil**  
 Conexel Conexoes Elétricas Ltda.  
 Rua Garcia Lorca, 176- V. Paulicéia,  
 09695-900, Sao Bernardo do  
 Campo - SP, Brasil  
 Phone +55 11 43669600  
 Fax +55 11 43621677  
 vendas@conexel.com.br  
 www.conexel.com.br
- BY Belarus**  
 TECHNIKON Ltd.  
 Oktyabrskaya Str. 16/5  
 Apt. 704  
 220030 Minsk  
 Belarus  
 Phone +375 17 2104626  
 Fax +375 17 2275830  
 technikon@belsonet.net
- CA Canada**  
 W Interconnections Canada Inc.  
 10 Spy Court, Markham,  
 Ontario L3 R5 H6  
 Phone +1 905 475-1507  
 Fax +1 905 475-5855  
 info1@weidmuller.ca  
 www.weidmuller.ca
- CH Switzerland**  
 Weidmüller Schweiz AG  
 Rindbuckstrasse 2  
 8212 Neuhausen am Rheinflall  
 Phone +41 52 6740707  
 Fax +41 52 6740708  
 info@weidmueller.ch  
 www.weidmueller.ch
- CL Chile**  
 Felipe Bahamondes S.A./ATS AGRO  
 Servicios Agroindustriales  
 Maria Luisa Santander 0475  
 Providencia  
 Casilla 3425  
 Santiago  
 Phone +56 2 341-1271  
 Fax +56 2 341-1275  
 felipe@atsintech.com
- CN China**  
 Weidmüller Interface International  
 Trading (Shanghai) Co., Ltd.  
 12 F, Century Ba-Shi Building,  
 No. 398 Huaihai Road (M)  
 Shanghai 200020  
 P.R. China  
 Phone +86 21 63868188  
 Fax +86 21 63867177  
 www.cnweidmuller.com
- CO Colombia**  
 Automatizacion Avanzada S. A.  
 Carrera 97 No. 42 A-23 B3,  
 Santafe de Bogotá Colombia.  
 Phone +57 1 4132048  
 Fax +57 1 4159788  
 mgallegos@  
 automatizacionavanzada.com
- CR Costa Rica**  
 ELVATRON S.A.  
 400 Norte  
 Banco Costa Rica, la Uruca,  
 San José, Costa Rica  
 Phone +506 2 961060  
 Fax +506 2 960328  
 dirk.haase@elvatron.com
- CS Serbia and Montenegro**  
 ES-YU Elektrosistem  
 Pariske komune 41  
 11070 Novi Beograd  
 Serbia  
 Phone +381 11 697212  
 Fax +381 11 693608  
 esyu@eunet.yu  
 www.elektrosistem.co.yu
- CZ Czech Republic**  
 Weidmüller s. r. o.  
 Videnska ul. 340  
 25242 Vestec u Prahy  
 Phone +420 2 44001400  
 Fax +420 2 44001499  
 office@weidmueller.cz
- DE Germany**  
 Weidmüller GmbH & Co. KG  
 Ohmstraße 9  
 32758 Detmold  
 Phone +49 5231 1428-0  
 Fax +49 5231 1428-116  
 weidmueller@weidmueller.de  
 www.weidmueller.de
- DK Denmark**  
 Knud Wexøe A/S  
 Skaettekaeret 11  
 P.O. Box 152  
 2840 Holte  
 Phone +45 45465800  
 Fax +45 45465801  
 wexoe@wexoe.dk
- EE Estonia**  
 Alter Electric OÜ  
 Türi 6, 11313 Tallinn, Estonia  
 Phone +372 65 19 666  
 Fax +372 65 19667  
 alter@alter.ee
- EG Egypt**  
 Standard Electric  
 87, Mohamed Farid Street  
 Heliopolis, Cairo, Egypt  
 Phone +20 6 42 2977/6 42 29 88  
 Fax +20 6 42 29 55  
 stdelec@rite.com
- ES Spain**  
 Weidmüller S. A.  
 Narcis Monturiol 11-13  
 Pol.Ind. Sudoeste  
 08960 Sant Just Desvern  
 Barcelona  
 Phone +34 93 4803386  
 Fax +34 93 3718055  
 weidmuller@weidmuller.es  
 www.weidmuller.es
- FI Finland**  
 JUHA-ELEKTRO OY  
 Kylvöpolku 6, P. O. Box 57  
 00681 Helsinki  
 Phone +358 9 4784111  
 Fax +358 9 47841311
- FR France**  
 Weidmüller EURL  
 12, Chaussée Jules César  
 B.P. 263 Osny  
 95523 CERGY PONTOISE Cedex  
 Phone +33 1 34245500  
 Fax +33 1 34245501  
 mail@weidmuller.fr  
 www.weidmueller.com
- GB United Kingdom**  
 Weidmuller Ltd.  
 1 Abbey Wood Road  
 Kings Hill, West Malling  
 Kent ME19 4YT  
 Phone +44 1732 877000  
 Fax +44 1732 873873  
 info@weidmuller.co.uk  
 www.weidmueller.com
- GR Greece**  
 Electrorama S.A.  
 1 An. Martali Str.  
 41335 Larissa  
 Phone +30 2410 552533  
 Fax +30 2410 283463  
 valvizos@electrorama.com.gr
- HK Hong Kong**  
 United Equity Limited  
 Suite B, 11/F International Industrial  
 Centre  
 2-8 Kwei Tei Street, Fotan, Shatin  
 Hong Kong  
 Phone +852 26876739  
 Fax +852 26876735  
 united\_equity@sinatown.com
- HR Croatia**  
 Elektro Partner d.o.o.  
 Radnicka cesta 22  
 10000 Zagreb  
 Phone +385 1 6184793  
 Fax +385 1 6184795  
 elektropartner@zg.htnet.hr
- HU Hungary**  
 Weidmüller Kereskedelmi Kft  
 Dombóvári út 13  
 1117 Budapest  
 P. O. Box 22  
 1507 Budapest  
 Phone +36 1 464-7888  
 Fax +36 1 3827701  
 info@weidmueller.hu
- ID Indonesia**  
 P. T. Nego Electrindo  
 Komplek Sentra Kramat, Blok A18  
 Jl. Kramat Raya No. 7-9  
 Jakarta 10450 Indonesia  
 Phone +62 21 3156218  
 Fax +62 21 3156219  
 sutrisno@negoelectrindo.co.id
- IE Ireland**  
 A.P. Haslam Ltd.  
 14 Sunshine Ind. Estate  
 Crumlin Road  
 Dublin 12  
 Phone +353 1 453-2522  
 Fax +353 1 453-2949  
 paul.haslam@aphaslam.ie
- IL Israel**  
 A.U. Shay Ltd.  
 Embar Street 23/25  
 P.O.Box 10049  
 Petach-Tikva 49222  
 Phone +972 3 9233601  
 Fax +972 3 9234601  
 shay@uriel-shay.com
- IN India**  
 Weidmüller  
 Representative office  
 Vijay Dattani  
 # 156-4th cross, Prashant Extension  
 Whitefield  
 Bangalore - 560 066  
 Phone +91 80 8453999  
 vtdattani@eth.net
- IR Iran**  
 TAF Co.  
 72, Iranshahr Av.  
 Unit 5,  
 15816 Teheran  
 Phone +98 21 8831-7851  
 Fax +98 21 8882-0268  
 info@taf-co.com
- IS Iceland**  
 Samey Automation Center  
 Lyngas 13, 210 Garoabaer,  
 Iceland  
 Phone +354 510 5200  
 Fax +354 510 5201  
 samey@samey.is
- IT Italy**  
 Weidmüller S.r.l.  
 Via Albert Einstein 4  
 20092 Cinisello Balsamo  
 Milano  
 Phone +39 02 660681  
 Fax +39 02 6124945  
 weidmuller@weidmuller.it  
 www.weidmuller.it
- JO Jordan**  
 Horizons Engineering  
 P.O. Box 330607 ZC  
 11133 Amman  
 Phone +962 64882114  
 Fax +962 4882115  
 horizons@go.com.jo
- JP Japan**  
 Nihon Weidmüller Co. Ltd.  
 Asahi Seimei Bldg. 11F  
 1-14-1 Fuchicho Fuchu-shi  
 Tokyo 183-0055 Japan  
 Phone +81 42 330-7891  
 Fax +81 42 330-7895  
 www.weidmuller.co.jp
- KR South Korea**  
 Weidmüller Co., Ltd.  
 2 floor Wooman B/D 46-27  
 Samsung2-Dong, Kangnam-Ku  
 Seoul  
 Korea, Zip: 135-868  
 Phone +82 2 5160003  
 Fax +82 2 5160090  
 info@weidmuller.co.kr
- KW Kuwait**  
 NOURI Industrial Establishment Co.  
 P.O.Box 2829,  
 Safat 13029 Kuwait  
 Phone +965 4333355  
 Fax +965 4344085  
 contact@nie-kwt.com
- KZ Kazakhstan**  
 SEA STAR  
 58-A, Office 609, Abilay Khan Aven.  
 Almaty, 50004  
 Kazakhstan  
 Phone +7 3272 733307  
 Fax +7 3272 501780  
 alexander@seastargroup.com
- KZ Kazakhstan**  
 Electric Light LLP  
 84, Auezov Street  
 Office 310  
 480057 Almaty  
 Kazakhstan  
 Phone +7 3272 421709  
 Fax +7 3272 779955  
 wgm@nursat.kz

- LB Lebanon**  
Progress Engineering & Trading Enterprises  
P.O. Box 11-1111  
Pharaon Bldg., Opp Electr. du Liban  
Chafaca Str., Al Nahr  
Beirut - Lebanon  
Phone +961 1 444664  
Fax +961 1 561880  
progress@inco.com.lb
- LT Lithuania**  
ELEKTROS IRANGA  
Tinklu g.29a, 5319 Panevezys,  
Lithuania  
Phone +370 45582828  
Fax +370 45582727  
info@eliranga.lt
- LU Luxembourg**  
Please contact  
Weidmüller Belgium, Heverlee
- LV Latvia**  
Elekrosistemas SIA  
K. Ulmana gatve 140  
LV-1029 Riga  
Latvia  
Phone +371 7870557  
Fax +371 7870541  
edgars.vilkins@profs.lv  
www.profs.lv
- MK Macedonia**  
ES MK Elektrosistem d.o.o.  
Ul. Bulevar III makedonske brigade bb  
91000 Skopje  
Macedonia  
Phone +389 91 460295  
Fax +389 91 460298  
elektro-smk@telekabel.net.mk
- MX Mexico**  
W Interconnections, S.A. de C.V  
Av. Ingenieros Civiles No. 204-B,  
Conjunto Industrial Chachapa  
72990 Chachapa,  
Puebla Mexico  
Phone +52 222 2866247/48/49  
Fax +52 222 2866242  
clientes@weidmuller.com.mx
- MY Malaysia**  
Connect Plus Technology Sdn Bhd  
9, Jalan PJS 11/24,  
Bandar Sunway,  
46150 Petaling Jaya,  
Selangor Darul Ehsan,  
Malaysia  
Phone +60 3 5633 7363  
Fax +60 3 5633 6562  
andy@cptech.com.my  
www.cptech.com.my
- NL Netherlands**  
Weidmüller Benelux B.V.  
Franciscusweg 221  
1216 SE Hilversum  
Postbus 1505  
1200 BM Hilversum  
Phone +31 35 6261261  
Fax +31 35 6234569  
info@weidmuller.nl  
www.weidmuller.nl
- NO Norway**  
Siv. Ing. J. F. Knudtzen A/S  
Billingstadsletta 97  
1396 Billingstad, P.O. Box 160  
1378 Nesbru  
Phone +47 66 983350  
Fax +47 66 980955  
patorgersbraaten@jfknuadtzen.no
- NZ New Zealand**  
Cuthbert S. Steward Limited  
27 Te Puni Street  
POB 38496 Petone  
Petone, Wellington  
Phone +64 4 5686156  
Fax +64 4 5686056
- OM Oman**  
DAN INTERNATIONAL LLC.  
P.O. BOX 2901  
111 Seeb  
Oman  
Phone +968 503 677  
Fax +968 503 755  
yedu@danintl.com
- PE Peru**  
TECNOLOGÍA ELÉCTRICA  
Y SOLUCIONES S.A.C.  
Calle Huandoy 501, Lima 32 - Perú  
Phone +51 1 5620004  
Fax +51 1 5620004  
info@tecsol-peru.com
- PH Philippines**  
El Criscent Corporation  
B-41 L-10, Villa Palao,  
Banlic, Calamba City  
Laguna 4027,  
Philippines  
Phone +63 49 3456329  
Fax +63 49 3456329  
ecc@laguna.net
- PH Philippines**  
Enclosure Systems Specialists Inc  
G/F, GE Building  
2291 Don Chino Roces Ava Ext  
Makati City 1231,  
Philippines  
Phone +63 2 813 8580  
Fax +63 2 813 8596  
encsys@mozcom.com
- PL Poland**  
Weidmüller Sp. z o.o.  
ul. Golezdzinowska 10  
03-302 Warszawa  
Poland  
Phone +48 22 5100940  
Fax +48 22 5100941  
biuro@weidmuller.com.pl  
www.weidmuller.pl
- PT Portugal**  
Weidmüller - Sistemas de  
Interface, S. A.  
Estrada Outeiro Polima, Lote B,  
N° B2, Escritório 2 - Abóboda  
2785-518 Sao Domingos de Rana  
Lisboa  
Phone +351 21 4459190  
Fax +351 21 4455871  
weidmuller@weidmuller.pt  
www.weidmuller.pt
- PY Paraguay**  
Rewo Paraguay S.A.  
Sucre 2590 esq Emeterio Miranda  
Asunción  
Paraguay  
Phone +595 21 60 60 13  
Fax +595 21 60 60 13  
rewo@telesurf.com.py
- QA Qatar**  
Doha Motors  
(Technical Division)  
Post Box No. 145  
Al Wakrath Road  
Doha-Qatar  
Phone +974 465 1441  
Fax +974 465 4579  
dmtctech@qatar.net.qa
- RO Romania**  
Rominterface Impex SRL  
Str. Gh. Dem Teodorescu 30A  
030916 Bukarest - sector 3  
Phone +40 21 3220230  
Fax +40 21 3228857  
romint@dnt.ro
- RU Russia**  
Weidmüller Representative Office  
Shabolovka street 2  
119049 Russia, Moskau  
Phone +7 495 771-6940  
Fax +7 495 771-6941  
info@weidmueller.ru  
www.weidmueller.ru
- SA Saudi Arabia**  
Al Abdulkarim Trading  
P.O. Box 5777, Dammam  
31432 Saudi Arabia  
Phone +966 3 833-7110  
Fax +966 3 833-8242  
info@akte.com.sa
- SA Saudi Arabia**  
Saudi Electric Supply Co.  
P.O. Box 3298, Al Khobar  
31952 Saudi Arabia  
Phone +966 3 882-9546227  
Fax +966 3 882-9547  
customer.service@sesco-ge.com
- SE Sweden**  
Weidmüller AB  
Stockholm, Arenavägen 39,  
12177 Johanneshov  
P.O. Box 10120  
12128 Stockholm-Globen  
Phone +46 771 43 00 44  
Fax +46 8 7272480  
mail.stockholm@weidmuller.se
- SG Singapore**  
Weidmüller Pte. Ltd.  
629 Aljunied Road, #05-05  
Cititech Industrial Building  
Singapore 389838  
Phone +65 6841 5311  
Fax +65 6841 5377  
info@weidmuller.com.sg  
www.weidmuller.com.sg
- SI Slovenia**  
ELEKTROPOJIL d.o.o.  
Stegne 25  
1000 Ljubljana  
Phone +38 6 15113810  
Fax +38 6 15111604  
elektrospojil@siol.net
- SK Slovakia**  
Elektris s.r.o.  
Racianska 188  
SK 83153 Bratislava, Slovakia  
Phone +421 2 49200113  
Fax +421 2 44680328  
weidmueller@computel.sk
- SY Syria**  
Hovaguimian Bros.  
P.O. Box 5093  
Damascus  
Syria  
Phone +963 11-221 84 05  
Fax +96311-224 48 69  
Hb.hovag@mail.sy
- TH Thailand**  
Pisanu Engineering Co., Ltd  
800/2 Asoke Dindaeng Road,  
Dindaeng,  
Bangkok 10400  
Thailand  
Phone +66 2 2459113  
Fax +66 2 2463214  
ecsales@pisanu.co.th  
www.pisanu.co.th
- TR Turkey**  
Weidmüller Elektronik Ticaret Ltd.Şti.  
Kavacik Mah. Mhrrabad Cad. 143/1  
34810 Beykoz - Istanbul / Turkey  
Phone +90 216 5371070 (Pbx)  
Fax +90 216 5371077  
info@weidmuller.com.tr
- TW Taiwan**  
Fittatek Co., Ltd.  
12 F No. 185 Fu-Kuo Road,  
Tso Ying Dist,  
Kaohsiung, Taiwan  
Phone +886 7556-0858  
Fax +886 7556-3279  
stanley@fittatek.com.tw
- TW Taiwan**  
Eucan Enterprise Ltd.  
No. 145 He Ping 2nd Rd  
Kaohsiung, Taiwan  
Phone +886 7 715 6610  
Fax +886 7 715 8748  
mark@eucan.com.tw  
www.eucan.com.tw
- UA Ukraine**  
TEKO Interface  
Per.Industrialny 2  
03056 - Kiev  
Phone +380 04463 57760  
Fax +380 04463 91082  
elektro@panko.kiev.ua
- US USA**  
W-Interconnections, Inc.  
821 Southlake Boulevard,  
Richmond, VA 23236  
Phone +1 804 7942877  
Fax +1 804 3792593  
info@weidmuller.com  
www.weidmuller.com
- UY Uruguay**  
Rewo Uruguay S.A.  
Av. Bolivia 2001 Esq Rocafuerte  
Carrasco Montevideo  
Phone +598 260 4 8439  
Fax +598 260 4 8439  
clorda@rewo Uruguay.com.uy
- VE Venezuela**  
Somernica C. A.  
Edificio Esteban Piso 2  
Calle Vargas Bolleita Notre  
Caracas 1070 A  
Venezuela  
Phone +58 212 2352748  
Fax +58 212 2385625  
klocmoeller@cantv.net
- VN Vietnam**  
New Sky Co., Ltd  
206 Nguyen Thai Binh Str.,  
Ward 12., Tan Binh Dist.,  
Ho Chin Minh City  
Vietnam  
Phone +848 811 6768  
Fax +848 811 7899  
newsky-e@hcm.vnn.vn  
www.newsky-e.com
- YE Yemen**  
Please contact  
Weidmüller Middle-East  
United Arab Emirates
- ZA South Africa**  
RAD Interface Pty. Ltd.  
5 Bundo Road  
Sebenza Extension  
Edenvale 1609  
P.O.Box 193  
Edenvale 1610  
Phone +27 11 452-1930  
Fax +27 11 452-6455  
alockyer@radinterface.co.za
- DE Other countries**  
Weidmüller Interface GmbH & Co. KG  
P.O. Box 3030  
32720 Detmold  
Klingenbergstraße 16  
32758 Detmold  
Phone +49 5231 14-0  
Fax +49 5231 14-20 83  
info@weidmueller.com  
www.weidmueller.com
- DE** Group companies
- DE** Agency abroad
- DE** Without own Agency

Argentina	Ireland	Slovenia
Australia	Israel	South Africa
Austria	Italy	South Korea
Azerbaijan	Japan	Spain
Bahrain	Jordan	Sweden
Belarus	Kazakhstan	Switzerland
Belgium	Kuwait	Syria
Bosnia-	Latvia	Taiwan
Herzegovina	Lebanon	Thailand
Brazil	Lithuania	Turkey
Bulgaria	Luxembourg	UAE
Canada	Macedonia	Ukraine
Chile	Malaysia	United Kingdom
China	Mexico	Uruguay
Colombia	Netherlands	USA
Costa Rica	New Zealand	Venezuela
Croatia	Norway	Vietnam
Czech Republic	Oman	Yemen
Denmark	Paraguay	
Egypt	Peru	
Estonia	Philippines	
Finland	Poland	
France	Portugal	
Germany	Qatar	
Greece	Romania	
Hong Kong	Russia	
Hungary	Saudi Arabia	
Iceland	Serbia/	
India	Montenegro	
Indonesia	Singapore	
Iran	Slovakia	

**Weidmüller is the leading manufacturer of components for electrical connection technology. The Weidmüller product portfolio ranges from terminal blocks, PCB connectors and terminals, protected components, Industrial Ethernet components and relay sockets to power supply and overvoltage protection modules suitable for all applications. Electrical installation and marking material, basic I/O components and a variety of tools round off the range. As an OEM supplier, the company sets global standards in the field of electrical connection technology.**

We cannot guarantee that there are no mistakes in the publications or software provided by us to the customer for the purpose of making orders. We try our best to quickly correct errors in our printed media. For this purpose we list corrections, which have been identified after publishing printed media, on our web site at [www.weidmueller.com](http://www.weidmueller.com). For convenience we list these corrections against product catalogue number and/or page number. This Internet-database is part of our catalogue.

All orders are based on our general terms of delivery, which can be reviewed on the websites of our group companies where you place your order. On demand we can also send the general terms of delivery to you.

**EAN GB:  
4032248608294**

Order number:  
5653630000/03/2006/DMMD

